



[cxmed.com](http://cxmed.com)

# Z-MOTION

## UNIVERSAL DIAGNOSTIC X-RAY SYSTEM



# A UNIVERSAL DIAGNOSTIC SUITE THAT MEETS ALL YOUR NEEDS

- Single detector general purpose radiographic system
- Preset positions for fast and convenient workflow
- Extra-wide (100-200 cm) SID range
- Auto-stitching for full-spine or full-leg procedures
- Advanced anti-collision features
- Suite of accessories including mobile Z-Table and Stitching stand

- ✓ **FULLY MOTORIZED**
- ✓ **MANUAL OVERRIDE**
- ✓ **PRESET POSITIONS**
- ✓ **AUTO-STITCHING**



PERFORMANCE



COMPACT DESIGN



SAFETY



MULTIPURPOSE



► This brochure features both standard and optional elements.

# FEATURES TO INCREASE PATIENT THROUGHPUT, CHOICE OF STUDIES AND OPERATOR COMFORT

## BEST-IN-CLASS SID RANGE

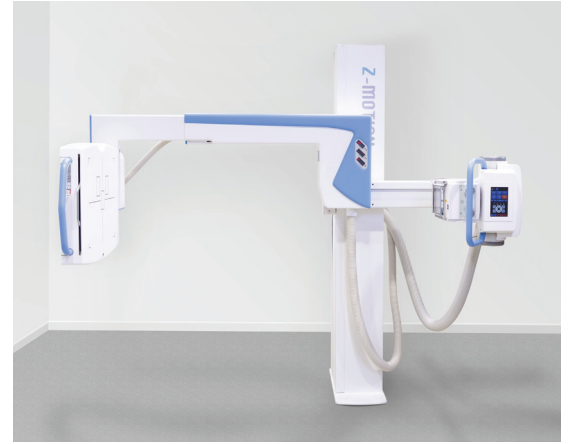
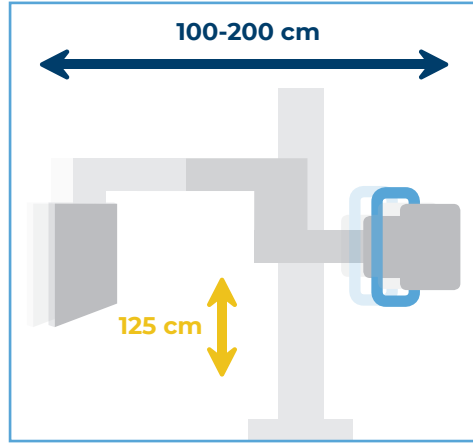

## OBLIQUE STUDIES IN 180° RANGE

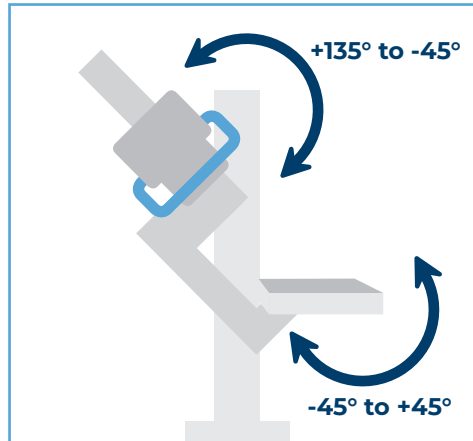

## AUTO-STITCHING FOR FULL-SPINE OR FULL-LEG PROCEDURES - CONSTANT FOCUS POINT (2 OR 3 FRAMES)

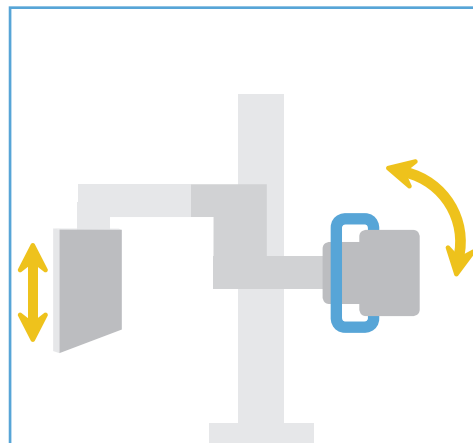
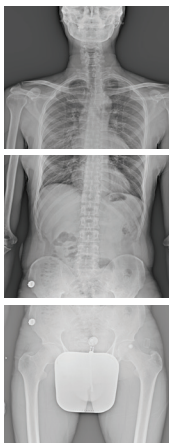



## STITCHING STAND

- Reduced patient movement for optimal image quality
- High patient comfort and safety
- Adjustable handles
- Easily maneuverable on 4 castors

## TOUCHSCREEN CONSOLE AND TUBE ASSEMBLY

- User programmable preset positions
- Automatic landscape/portrait view
- Access to stitching workflow
- Optional motorized collimator
- Rotating tube assembly (180°) for flexible positioning

## FULLY COUNTERBALANCED CONSTRUCTION

- Quick and easy manual positioning
- Low impact motors for maximum patient safety
- Proximity sensors to prevent collision



## FULL-FUNCTION REMOTE CONTROL

- Bluetooth wireless operation
- Access to all motorized functions of the system



## DETECTOR-SIDE HANDLE AND CONTROL

- Precise adjustment to patient height
- Remote collimator light switch
- System status displays
- Configurable brake release switch

## Z-TABLE

- Portable four-way radiographic table
- Mechanical brake release, no power cord
- Optimal for lateral exposures with short SID
- Large castors for easy maneuverability

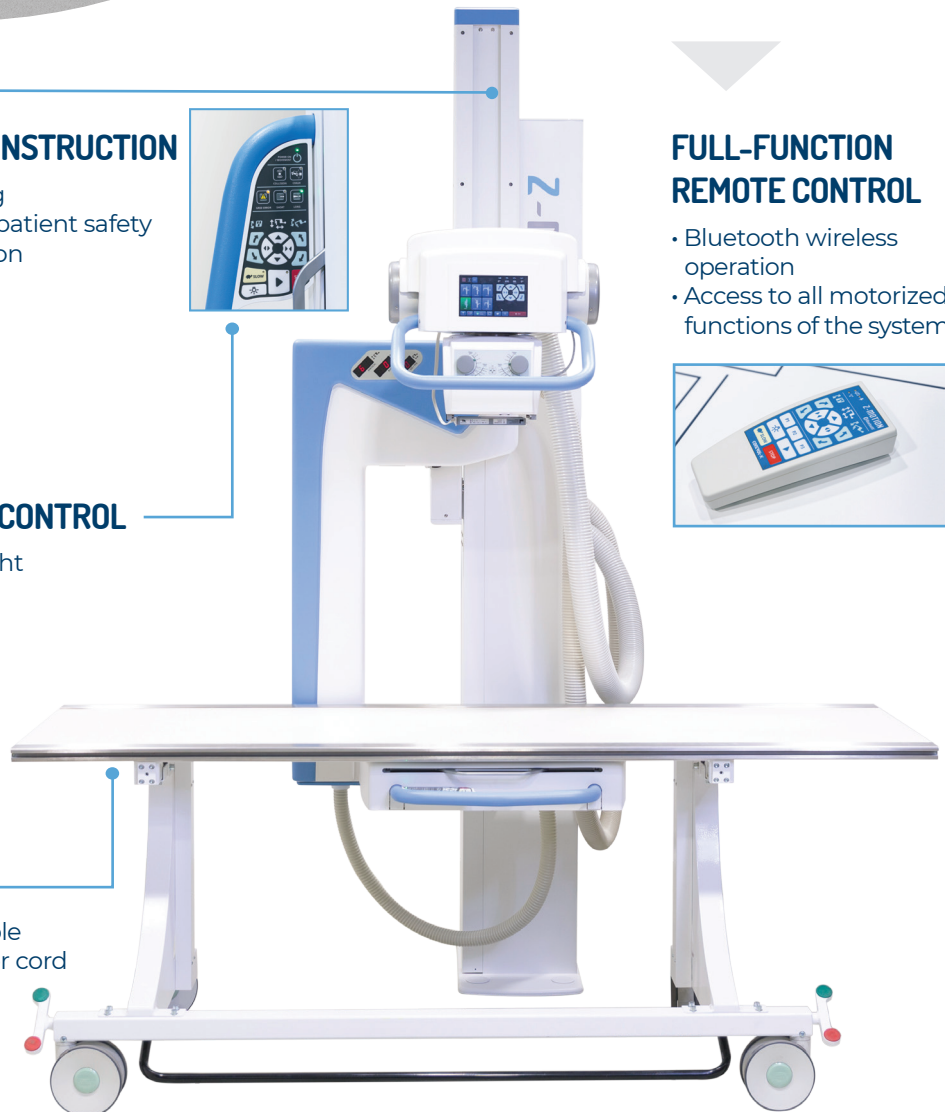

# SPECIFICATIONS

## Z-MOTION MOTORIZED STAND

Motorized movements	4 movements with electric brakes and clutches
Vertical motion range	125 cm (49 1/4") (motorized and manual)
Adjustable SID	100 to 200 cm (39 1/2" to 78 3/4") (motorized and manual)
Arm rotation	-45° to +135° (motorized and manual)
Detector tilt	-45° to +45° (motorized)
X-ray tube rotation	180° (non-motorized)
Manual movement	Counterbalanced horizontal, vertical and rotational movement
Tube-side control	7" LCD screen with automatic image rotation
Remote control (optional)	Wireless

## FOUR-WAY FLOATING TOP Z-TABLE (OPTIONAL)

## HIGH FREQUENCY GENERATOR

Tabletop size	200 cm x 66 cm (78 3/4" x 26")	Output Power	32, 40, 50, 65 or 80 kW
Fixed tabletop height	76 cm (30")	mA Range	10-1000 mA
Tabletop longitudinal travel	+/- 35 cm (13 3/4")	kVp Range	40-150 kV
Tabletop lateral travel	+/- 13,4 cm (5 1/4")	mAs Range	0.1-800 mAs
Patient load	Max. 150 kg (330 lb.)	Stored energy generators are available up to 50 kW power	

## X-RAY TUBE

## COLLIMATOR

300 kHU 0.6-1.2 mm focal spots (other tubes available)

Manual (optional automatic), Laser Guided LED collimator

## DIGITAL DETECTORS

Detector options

43x43 cm (17"x17") or 35x43 cm (14"x17") fixed or wireless panels with various resolutions available

## SYSTEM FOOTPRINT

Minimum floor space (W x D) without portable table	265 cm x 150 cm (4 m <sup>2</sup> ) 8'8"x5' (43 ft <sup>2</sup> )
Minimum floor space (W x D) with portable table	265 cm x 265 cm (7 m <sup>2</sup> ) 8'8"x8'8" (75 ft <sup>2</sup> )
Recommended floor space (W x D) without portable table	300 cm x 220 cm (6,6 m <sup>2</sup> ) 9'10"x7'3" (71 ft <sup>2</sup> )
Recommended floor space (W x D) with portable table	300 cm x 400 cm (12 m <sup>2</sup> ) 9'10"x13' (130 ft <sup>2</sup> )
Ceiling height requirement	240 cm (7' 10 1/2")

## POWER REQUIREMENTS (SYSTEM)

Input Line Voltage  
(Your input line properties may limit generator power)

1x230V (15A) for stored energy generators  
3x230V / 3x400V for three-phase generators

## INTEGRATED GENERATOR CONTROL AND IMAGE ACQUISITION

Single console seamless workflow:

- Full DICOM compatibility
- Integrated DAP reporting

Sophisticated image processing features:

- Detector status indicators
- Wifi signal strength indicator
- Wide variety of compatible detectors, wired or wireless, with various pixel sizes
- Portable solutions with tablet, laptop workstation
- Mini PACS included
- Cloud storage available
- Mobile viewing on any device

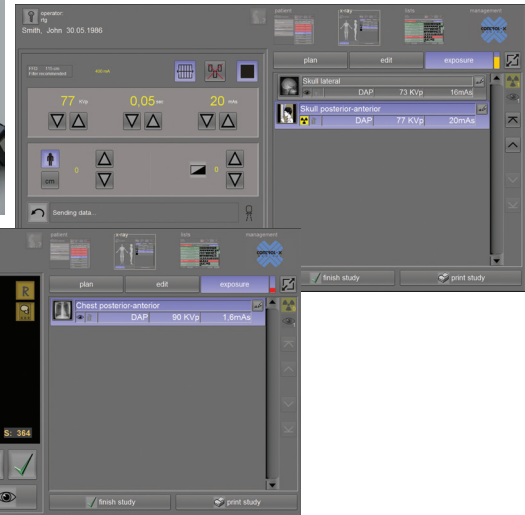

## REMOTE DIAGNOSTICS

Advanced diagnostic software allows troubleshooting and service to minimize downtime.

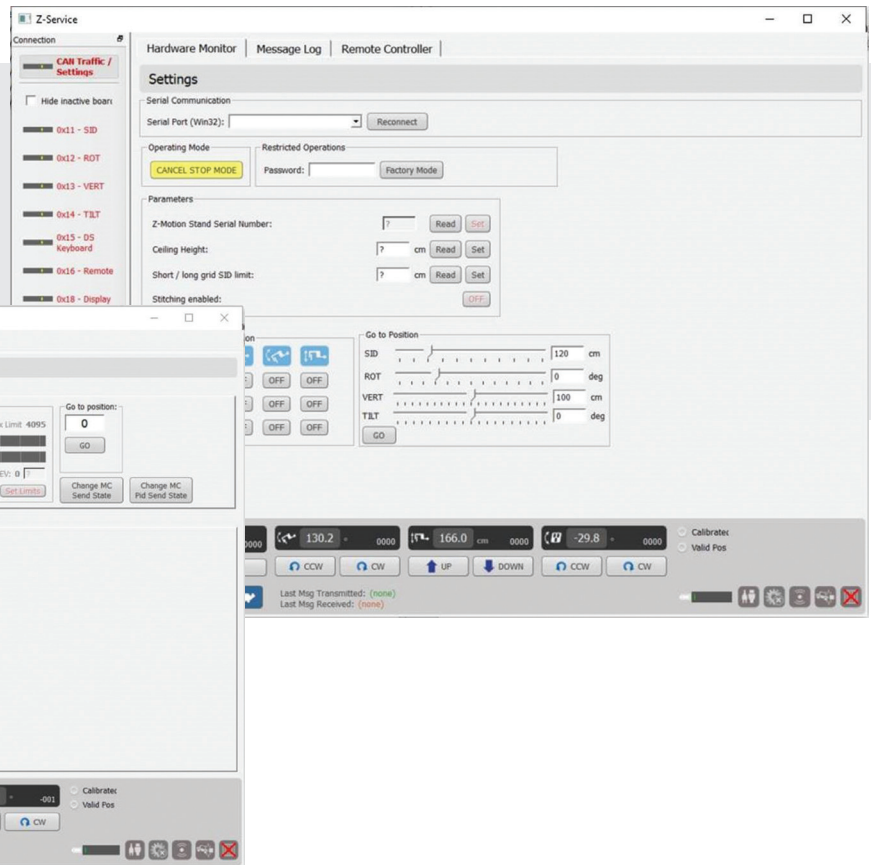

## CERTIFICATIONS

ISO 13485, CE marked and FDA cleared



Please contact us at [sales@cxmed.com](mailto:sales@cxmed.com)

Z-MOTION system brochure – Version 3.1 – June 2021

Authorized reseller:

**MEDIRAY GMBH**  
 X-RAY AND MEDICAL SOLUTIONS  
 Im Mittelfeld 5  
 79426 Buggingen  
[sales@mediray.de](mailto:sales@mediray.de)  
[www.mediray.de](http://www.mediray.de)